

Internet of Things Based Smart Environmental Monitoring Using the Raspberry-Pi

PALCHURI SURENDRA¹, M. AMARA LINGESWARARAO²

¹M.Tech Student Department of Electronics & Communication Engineering, Amara Institute of Engineering & Technology, Jawaharlal Nehru Technological University, Kakinada, AP, India

Email: palchurisurendra@gmail.com Mobile No:-9701410014.

²Sr. Assistant Professor, Department of Electronics & Communication Engineering, Amara Institute of Engineering & Technology, Jawaharlal Nehru Technological University, Kakinada, AP, India

Email: ceaiet@gmail.com Mobile no:-9000800236.

ABSTRACT

This paper proposes a way to deal with assemble a savvy institutionalized natural checking gadget utilizing the Raspberry-Pi (R-Pi) single-board PC. The framework was outlined utilizing Python Programming dialect and can be controlled and gotten to remotely through an Internet of Things stage.

It Gets some information about the encompassing condition through sensors and transfers it specifically to the web, where it can be gotten to whenever and anyplace through web. Trial comes about showed that the framework can precisely gauge: temperature, mugginess, light level and centralizations of the carbon monoxide destructive air contamination. It's likewise intended to distinguish tremors through a collected seismic sensor.

1. INTRODUCTION

The outline objective is to construct a wise remote control and observing with inserted Web server. The objective of a minimal effort, simple to utilize, and versatile answer for Web-empowered estimation and control frameworks can be accomplished by utilizing the accompanying key advancements.

- Component-based engineering
- true installed organizing
- Standard Internet advancements

What is embedded Technology:-The Embedded innovation is programming or equipment that is covered up installed in a huge gadget or framework. Installed frameworks, as opposed to universally useful PCs, for example, a work area, contain

processors, programming, input sensors and yield actuators which are all committed to the control of a particular gadget.

Block Diagram:

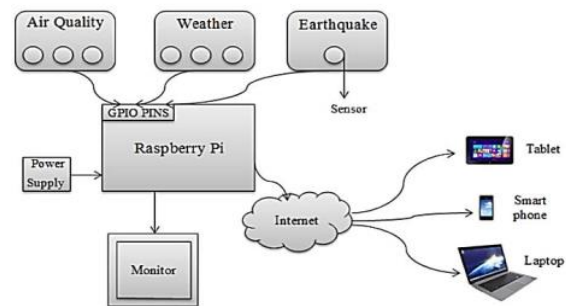

An installed framework is a designing ancient rarity including calculation that is liable to physical requirements (response imperatives and execution limitations) emerging through connections of computational procedures with the physical world. Response limitations start from the conduct necessities and indicate due dates, throughput, and jitter while execution imperatives begin from the usage prerequisites and put limits on accessible processor speeds, power, and memory and equipment disappointment rates. The way to inserted frameworks configuration is to get wanted usefulness under the two sorts of imperatives.

Block Diagram

(TRANSMITTER SECTION):-

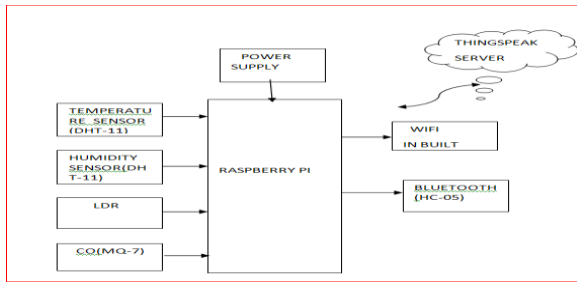

MONITORING TERMINALS (RECEIVER SECTION):



2. LITURE REVIEW

The writing has announced an extensive number of research efforts that make utilization of remote sensors for accomplishing checking applications. Donno et al. [25] propose an answer where self-powered Radio-recurrence recognizable proof labels, outfitted with temperature, light, and increasing speed sensors, are utilized. The gadget haste capacity to reap RF vitality and its activity has been validated through two true tests, in which the acquired information are gathered by a host PC with the assistance of reader reception apparatus. The outline accomplished a transmission extend of up to 10 and 20 m in completely inactive and battery-helped.

Passive modes, individually. The proposed framework can be utilized for monitoring the encompassing or outside climate parameters, and, if the host PC is furnished with an Internet association, can be part of an IOT-based solution. Reference [26] presents an open-source remote work networking module for ecological checking, with the aim of advancing this sort of steering in such applications. This is based on an ease RF handset, with more minimized endless complex code than the one of a ZigBee outline, and works in association with a sensor hub. The framework was compared to an off-the-rack item, XBee, with the conclusion that it can offer tantamount or shockingly better execution than commercial things. Different frameworks for

observing applications belonging to various fields, all in light of ZigBee, are reported in [6], [13], and [27]. The real downside of these consists in the necessity for a door in the event that information must be sent over the Internet, a fundamental prerequisite for IOT scenarios. Various observing arrangements in light of BLE innovation have appeared and are making progress particularly in home automation, after its presentation in 2010 [21]. The work in [28] consists in the advancement of a novel vitality management approach for keen homes in view of BLE empowered wireless networks. By offering low power, minimal effort, and reduced device measurements, the creators trust that this technology has a high capability of getting to be vital for both the IOT and for keen homes. This pattern will likewise be managed by the accessibility of local help offered by current mobile devices, contrasted with IEEE 802.15.4, which will likewise reduce the cost of BLE gadgets. The reenactment comes about demonstrate that this approach adds to the diminishment of pinnacle stack demand and power utilization charges, at last prompting

Financial funds. Besides, it has been demonstrated that the performance of the proposed BLE organize is better than the one acquired on account of IEEE 802.15.4 in wording of packet conveyance proportion, deferral, and jitter. With the continuous improvements conveyed to the convention, for example, the help for mesh organizing, and the expansion of the range offered, it disbelieved that this innovation will be taken into consideration for actualizing ecological checking applications. In [29], we announced the advancement of Wi-Fi sensors sending temperature and relative moistness estimations to base station utilizing UDP. A battery lifetime of 2 years with 20 min estimation cycle was accomplished. This encouraged the advancement of a gadget utilizing HTTP, for investigating the control proficiency of this more solid arrangement, from the correspondence perspective.

IOT and Raspberry PI Based Environmental Monitoring Application

This paper displays the remote sensor arrange framework and Internet of things (IOT), by utilizing WSN it builds up an open source equipment stage, raspberry pi (2B model), zigbee and sensors. It is ease, low power devouring gadget and very adaptable in a sort of sensors and the quantity of sensor hubs. Sensor hub is a blend of sensor, controller and XBee module, which makes it appropriate for a wide

assortment of utilizations identified with ecological checking. The Internet of Things (IOT) is a developing key innovation for future enterprises, and ecological observing. The raspberry pi is the least expensive ARM11 controlled Linux working framework single board PC. Raspberry Pi fills in as a base station which associates the quantity of dispersed sensor hubs by means of zigbee convention. In the remote sensor organizes the zigbee is an abnormal state correspondence convention used to make a remote systems, it comprise of a three modes, for example, end labels, switch, and facilitator. Organizer straightforwardly speaks with a base station. In remote sensor arrange framework the sensor hub sense the information from the sensor and that information gathers the end labels, end labels send its information to the switch and switch to facilitator and supply multi-customers administrations including information show, the entire information will be put away in base station and the put away information will send to the cloud (Ethernet) and furthermore the customer can visit the base station remotely by means of (site) Ethernet. Such a sensors are temperature, vibration, weight, dampness, light, and contamination.

The objective is to assemble a little and simple to utilize gadget to screen temperature, stickiness, clamor levels, iridescence and barometrical weight.

The thought is to have different gadgets spread over the city to send natural information to the AWS IOT stage for preparing and examination. With this constant information, new open administrations could be offered, for instance:

- Trigger cautions if there should arise an occurrence of risky estimations recognized
- Finding out the less contaminated places in the city at a given time: parks, squares or any open outside spots.
- Find out high contaminated spots to stay away from
- Find out the estimations from the closest checking gadget

This gadget is proposed to be utilized and overseen by anybody with no other prerequisite than a web association and an accessible outside place at home: for instance, overhang, a window, a rooftop, cultivate, and so forth . .

Just by stopping the gadget, it will naturally begin detecting and sending information to the cloud.

Environment Monitoring System utilizing Raspberry-Pi

The advancement in implanted framework has demonstrated to a solid arrangement in observing and controlling nature checking framework. The undertaking goes for building a framework which can be utilized on generally at any scale to screen the parameters in a given domain. With the advancement of scaled down sensor gadgets combined with remote advances it is conceivable to remotely screen the parameters, for example, temperature, dampness, sum ofco2 in air and some more .We will utilize raspberry-pi as our fundamental load up and sensors will gather all the ongoing information from condition and this constant information will be brought by the web server and show it. Client can get to this information from anyplace through Internet. Because of unnatural and unusual climate agriculturists now daily face extensive budgetary misfortunes because of wrong expectation of climate and off base water system strategies and the measure of pesticides and bug sprays utilized for crops. This framework will demonstrate to be an essential part being developed in agrarian field.

3. HARD WARE AND SOFT WARE REQUIREMENTS

Hard Ware Requirements

1. Raspberry-Pi
2. Serial convention
3. Temperature sensor
4. Humidity sensor
5. Light level (LDR)
6. CO sensor
7. Earthquake sensor
8. Wi-Fi module
9. LCD
10. Power supply

Soft Ware Requirements

1. KEIL
2. Embedded C-dialect
3. Proteous.

4. RASPBERRY PI

What Is a Raspberry Pi?

The raspberry pi is a charge card estimated PC that fittings into your television and a console. It is a proficient little PC which can be utilized as a part of hardware ventures, and for a considerable lot of the things that your work area pc does, similar to spreadsheets, word-preparing and diversions. It likewise plays top quality video. We need to see it being utilized by kids everywhere throughout the world to figure out how PCs function, how to control the electronic world around them, and how to program.

The Raspberry Pi is a minimal effort, Master card estimated PC that fittings into a PC screen or TV, and utilizations a standard console and mouse. It is an able little gadget that empowers individuals of any age to investigate registering, and to figure out how to program in dialects like Scratch and Python. It can do all that you'd anticipate that a PC will do, from perusing the web and playing top notch video, to influencing spreadsheets, to word preparing, and playing recreations.

In addition, the Raspberry Pi can associate with the outside world, and has been utilized as a part of a wide cluster of computerized creator ventures, from music machines and parent identifiers to climate stations and tweeting doves with infra-red cameras. We need to see the Raspberry Pi being utilized by kids everywhere throughout the world to figure out how to program and see how PCs function. There are presently four Raspberry Pi models. They are the Model A, the Model B, the Model B+ and the Compute Module. All models utilize a similar CPU, the BCM2835, however other equipment highlights contrast.

THE MODEL B+

Discharged in July 2014, the Model B+ is a refreshed modification of the Model B. It builds the quantity of USB ports to 4 and the quantity of pins on the GPIO header to 40. Moreover, it has enhanced power hardware which permits higher fueled USB gadgets to be joined and now hot stopped. The full size composite video connector has been expelled and the usefulness moved to the 3.5mm sound/video jack. The full size SD card space has additionally been

supplanted with a considerably more powerful smaller scale SD opening.

Highlights:

- Low Power ARM1176JZ-F Applications Processor
- Dual Core Video Core IV® Multimedia Co-Processor
- 1080p30 Full HD H.264 Video Encoder/Decode
- Advanced Image Sensor Pipeline (ISP) for up to 20-megapixel cameras working at up to 220 megapixels every second
- Low control, elite OpenGL-ES® 1.1/2.0 Video Core GPU. 1 Gig pixel every second fill rate.
- High execution show yields. Concurrent high determination LCD and HDMI with HDCP at 1080p60

Regulated Power Supply

Power supply segment Transformer

A transformer is an electrical gadget which is utilized to change over electrical power starting with one electrical circuit then onto the next without change in recurrence

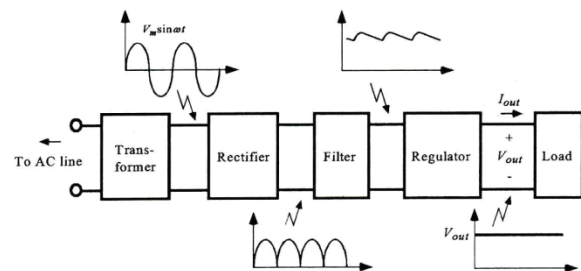

Components of a typical linear power supply

A Three Terminal Voltage Regulator 78XX

The Linear LM78XX is incorporated straight positive controller with three terminals. The LM78XX offer a few settled yield voltages making them helpful in extensive variety of utilizations. At the point when utilized as a zener diode/resistor blend substitution, the LM78XX more often than not brings about a viable yield impedance change of two requests of size, bring down quiet present.

Highlights

- Output Current of 1.5A
- Output Voltage Tolerance of 5%
- internal warm over-burden insurance
- Internal Short-Circuit Limited

- No External Component
- Output Voltage 5.0V, 6V, 8V, 9V, 10V, 12V, 15V, 18V, 24V
- Offer in plastic TO-252, TO-220 and TO-263
- Direct Replacement for LM78XX

Applications

- Post controller for exchanging DC/DC converter
- Bias supply for simple circuits

5. SENSORS

Introduction to Sensors

A sensor is a gadget that creates a quantifiable reaction to an adjustment in a physical condition, for example, temperature or warm conductivity, or to an adjustment in synthetic fixation. Sensors are especially valuable for making nearby estimations, for example, in mechanical process control. Sensors are a critical part to any estimation and computerization application. The sensor is in charge of changing over some sort of physical wonder into an amount quantifiable by a Data Acquisition System.

Picking Sensor

Components to consider while picking a sensor:

- Accuracy:** The measurable fluctuation about the correct perusing.
- Calibration:** Required for most estimating frameworks since their readings will float after some time.
- Cost
- Environmental:** Sensors regularly have temperature and additionally stickiness limits.
- Range: Limits of estimation or the sensor.
- Repeatability: The change in a sensor's perusing when a solitary condition is more than once estimated.
- Resolution: The littlest addition the sensor can identify.

LIGHT DEPENDENT RESISTORS (LDR'S)

Light Dependent Resistors (LDR's) are outstandingly significant especially in light/diminish sensor

circuits. Consistently the hindrance of a LDR is high, from time to time as high as 1000000 ω , yet when they are lit up with light restriction drops radically. The LDR is showed up in the Figure 8.1. LDR Diagram:

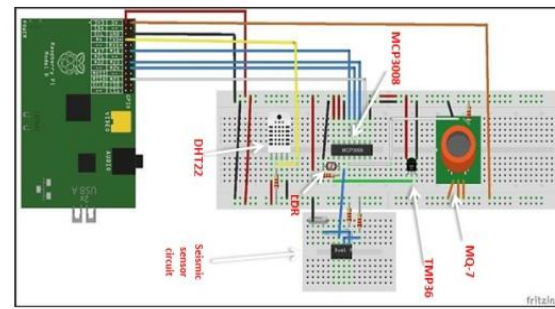
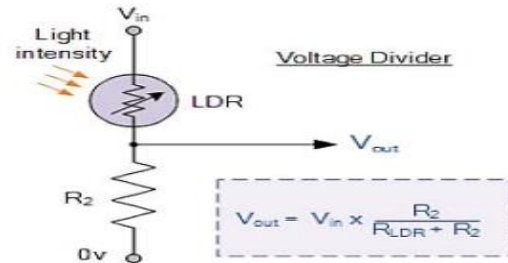

Light Dependent Resistors (LDR's)

Electronic opto sensors are the gadgets that change their electrical qualities, within the sight of obvious or undetectable light. The best known gadgets of these sorts are the LDR, the photograph diode and the phototransistors. Light reliant resistor as the name recommends relies upon light for the variety of obstruction.

Keep in mind the recipe for ascertaining Out:

$$V_{out} = \frac{R_{bottom}}{R_{bottom} + R_{top}} \times V_{in}$$

Features:

- High dependability
- Light weight
- Low cost

- wide ghostly reaction
- wide encompassing temperature run

DHT 11 Humidity & Temperature Sensor

DHT11 Temperature and Humidity Sensor include a temperature and mugginess sensor Complex with an adjusted advanced flag yield. By utilizing the elite advanced flag obtaining strategy and temperature and dampness detecting innovation, it guarantees high unwavering quality and amazing long haul solidness. This sensor incorporates a resistive-type moistness estimation part and a NTC temperature estimation segment, and interfaces with an elite 8-bit microcontroller, opening superb quality, quick reaction, hostile to impedance capacity and cost-effectiveness

DHT Responses to MCU (Figure 3, above)

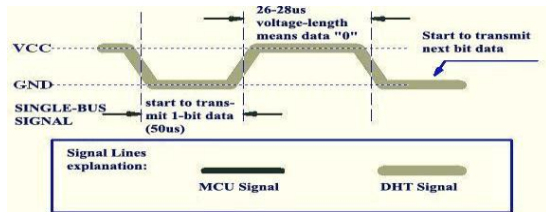

When DHT recognizes the begin flag, it will convey a low-voltage-level reaction flag, which keeps going 80us. At that point the program of DHT sets Data Single-transport voltage level from low to high and keeps it for 80us for DHT's planning for sending information.

At the point when DATA Single-Bus is at the low voltage level, this implies DHT is sending the reaction flag. When DHT conveyed the reaction flag, it pulls up voltage and keeps it for 80us and gets ready for information transmission.

At the point when DHT is sending information to MCU, all of information starts with the 50us low-voltage-level and the length of the accompanying high-voltage-level flag decides if information bit is "0" or "1" (see Figures 4 and 5 underneath).

MQ-7 GAS SENSOR

FEATURES

High affectability to carbon monoxide

Steady and long life

Available online: <https://edupediapublications.org/journa>

APPLICATION

They are utilized as a part of gas distinguishing gear for carbon monoxide (CO) in family and

Industry or auto.ParticularsA. Standard work condition

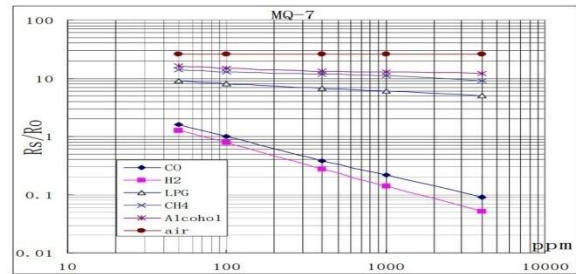

Demonstrates The Run Of The Mill Affectability Attributes Of The MQ-7 For A Few Gases.

In Their: Temp: 20°C,

Mugginess: 65%、

O2 Focus 21%

RL=10kω

Ro: Sensor Obstruction At 100ppm

CO In the Perfect Air.

Rs: Sensor Obstruction At Different

Centralizations Of Gases.

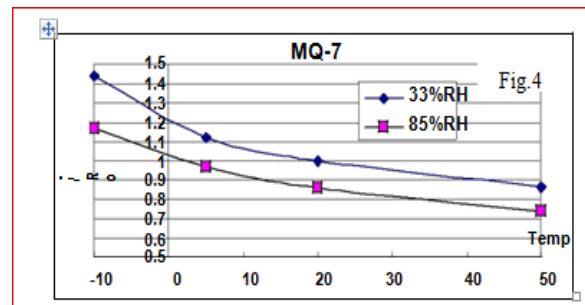

Affectability Attributes Of The MQ-7

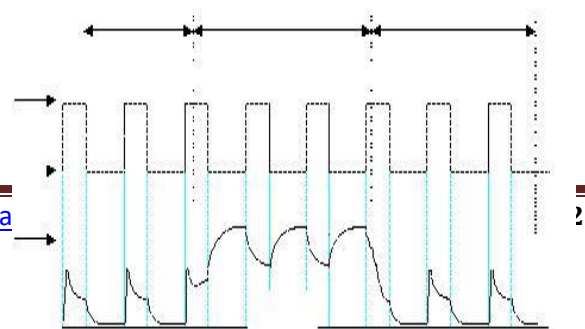

6. BLUETOOTH COMMUNICATION

Introduction

Bluetooth is a remote innovation standard for trading information over short separations (utilizing short-wavelength UHF radio waves in the ISM band from 2.4 to 2.485 GHz) from settled and cell phones, and building individual zone systems (PANs). Created by telecom seller Ericsson in 1994, it was initially considered as a remote contrasting option to RS-232 information links. It can interface a few gadgets, defeating issues of synchronization.

Bluetooth is overseen by the Bluetooth Special Interest Group (SIG), which has in excess of 19,000 part organizations in the zones of media transmission, processing, systems administration, and buyer hardware. Bluetooth was institutionalized as IEEE 802.15.1, however the standard is never again kept up. The SIG directs the improvement of the detail, deals with the capability program, and secures the trademarks. To be showcased as a Bluetooth gadget, it must be met all requirements to guidelines characterized by the SIG.

Usage:

Bluetooth works in the scope of 2400– 2483.5 MHz (counting monitor groups). This is in the all inclusive unlicensed (yet not unregulated) Industrial, Scientific and Medical (ISM) 2.4 GHz short-go radio recurrence band. Bluetooth utilizes a radio innovation called recurrence jumping spread range. The transmitted information are partitioned into bundles and every parcel is transmitted on one of the 79 assigned Bluetooth channels. Each channel has a data transmission of 1 MHz Bluetooth 4.0 utilizations 2MHz dispersing which takes into account 40 channels. The main channel begins at 2402 MHz and proceeds up to 2480 MHz in 1 MHz steps. It for the most part performs 1600 bounces for every second, with Adaptive Frequency-Hopping (AFH) empowered.

Create a Channel

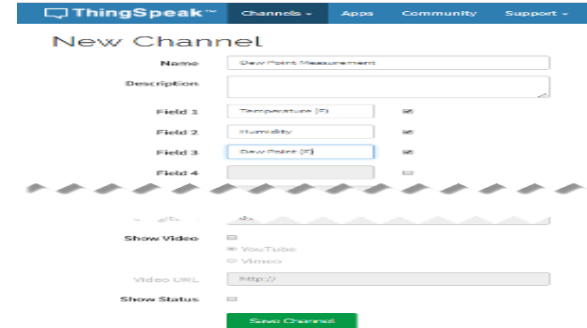

1. Sign In to Thing Speak™ utilizing your Math Works® Account, or make another Math Works account.
2. Click Channels > My Channels.
3. On the Channels page, click New Channel.
4. Check the cases alongside Fields 1– 3. Enter **these channel setting esteems:-**
5. Name: Dew Point Measurement
6. Field 1: Temperature (F)
7. Field 2: Humidity
8. Field 3: Dew Point

7. THINGSPEAK RESULT

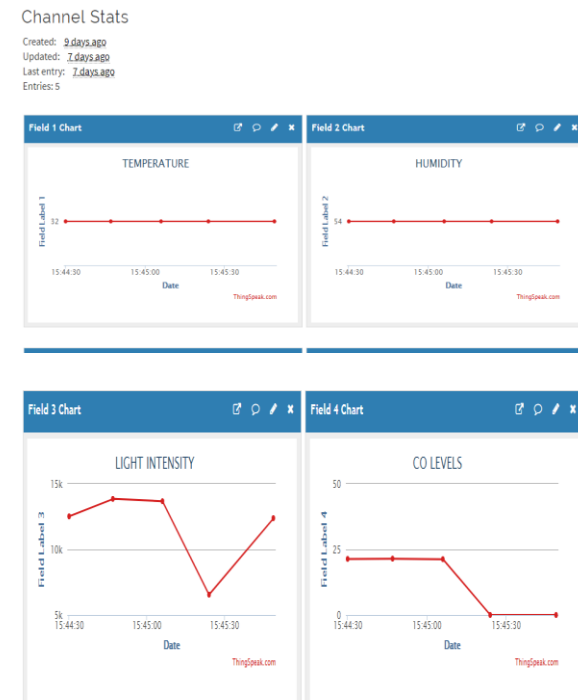

8. CONCLUSION

The climate checking framework may offer a few potential advantages; it gives observing administrations to remote territories and for specially appointed applications that are ordinarily not accessible from bigger observing frameworks possessed by governments and enormous agencies. The add up to life-cycle cost of the framework is limited and could hypothetically keep running for quite a long time altogether without the requirement for human intercession. Because of its capacity to naturally transfer to the web, one effectively set framework can give effortlessly open climate information to the entire network. It can be utilized to anticipate the beginning of terrible climate utilizing signs, for example, changing temperature and mugginess.

Here we are utilizing observing terminals compare HC-05(Bluetooth), Telnet terminal and similarly this quality is transferred to Things top Server. Raising the consciousness of how society is influenced the locale's natural approaches and have the information premise to push for the change.

9. REFERENCES

1. Traverse, E., Ceramic sensors for moistness discovery: The best in class and future improvements, Sens. Actuators B Chem. 1995.
2. Raman Wagram and Mohr Near Hamadan Humid Farrakhan, "Moistness sensors rule, system, and manufacture advances, an extensive survey," Sensors, 2014.
3. Donald Norris, Raspberry pi ventures for the detestable virtuoso, McGraw-Hill Education, 2014.
4. Analog Devices Inc., "Low voltage temperature sensors (TMP35/TMP36/TMP37) datasheet".
5. Mohammad M. Ibrahim, Abdelgha four Elgamri and Ahmed Mohamed, Environmental observing utilizing the raspberry-pi (En-Pi-ronment), Appendix A, 2014.
6. Wikipedia, [Online], http://en.wikipedia.org/wiki/Internet_of_Things.
7. Raspberry Pi Foundation, [Online], <http://www.raspberrypi.org/help/wh> at-is-a-raspberry-pi/.
8. Electronics instructional exercises, [Online], http://www.electronics-tutorials.ws/io/io_4.html.
9. Air Pi air quality and climate venture, [Online], <http://www.airpi.es>.
10. Ovidiu Vermesan, Peter Fri less, and Internet of Things: Converging Technologies for Smart Environments and Integrated Ecosystems.
11. Interscan Operation, Sensor Principle of Operation, <http://www.gasdetection.com/the-tech->

focus/instrument-sensor-execution/sensor-guideline of-activity/

12. Extended Environment Markup Language Protocol, <http://www.eeml.org>



M. Amara Lingeswararao Working as a Assistant Professor for Department of Electronics & Communication Engineering Amara Institute of Engineering & Technology, Jawaharlal Nehru Technological University, Kakinada, AP, India ,Email : ceaiet@gmail.com, Ph: 9000800236



Palchuri Surendra branch: department of electronics & communication engineering Mara institute of engineering & technology, Jawaharlal Nehru technological university, kakinada, Ap, India Email: palchurisurendra@gmail.com Mobile No:- 9701410014.