



Fuzzy Logic based MPPT & SOC control for a Stand-Alone Wind Energy Conversion System

Submitted by: **Kavya Lingampally**

Guide name: **Mr. J. Rakesh Sharan**

Department of Electrical and Electronics Engineering

ABSTRACT:

This paper presents a simple control strategy for the operation of a variable speed stand-alone wind turbine with a permanent magnet synchronous generator (PMSG). The PMSG is connected to a three phase resistive load through a switch mode rectifier and a voltage source inverter. Control of the generator side converter is used to achieve maximum power extraction from the available wind power. Control of the DC-DC bidirectional buck-boost converter, which is connected between batteries bank and DC-link voltage, is used to maintain the DC-link voltage at a constant value. It is also used to make the batteries bank stores the surplus of wind energy and supplies this energy to the load during a wind power shortage. The load side voltage source inverter uses a relatively complex vector control scheme to control the output load voltage in terms of amplitude and frequency. The control strategy works under wind speed variation as well as with variable load. Extensive simulation results have been performed using MATLAB/SIMULINK.

constant amplitude and frequency at the load side for electrical utilization. The reliability of the variable speed wind energy systems can be improved significantly by using a permanent magnet synchronous generator (PMSG). PMSG has several advantages over other types of generators which are used in wind energy systems such as its simple structure, ability of operation at slow speed, self-excitation capability leading to high power factor and high efficiency operation. With low speed of PMSG operation there is no need for a gearbox which often suffers from faults and requires regular maintenance making the system unreliable.

Maximum power can be extracted from the available wind power, which varies continually with change in the wind speed throughout a day, by adjusting the rotor speed of PMSG according to the wind speed variation. So, most recent papers try to achieve sensor less maximum power extraction from available wind power because using these mechanical sensors leads to inaccurate measurements due to mechanical parts consideration.

There are two common types of interfaces between PMSG and the load. The first configuration is designed as back-to-back PWM converter, the second configuration is a single switch mode rectifier and an inverter; the former is commonly considered as the technical ultimate operation but may be more expensive and complex, it has a lot of switches which cause more losses and voltage stress in addition to presence of Electromagnetic Interface (EMI). The latter, which is adopted in this paper, is usually used in the stand-alone or small scale wind farms for its simple topology and control, and most importantly, low cost.

There are many remote communities throughout the world where the electricity grid is not available. These communities are supplied with conventional energy sources. As it is well known,

I. INTRODUCTION

Nowadays, most countries of the world are facing difficulties in using conventional sources for power generation due to exhaustion of fossil fuels and environmental issues. Wind energy, is one of the available non-conventional energy sources, which is clean and an infinite natural resource. Variable speed wind energy systems have several advantages compared with fixed speed wind energy systems such as yielding maximum power output, developing low amount of mechanical stress, improving efficiency and power quality. Power electronics devices with a variable speed system are very important, where AC-DC converter is used to convert AC voltage with variable amplitude and frequency at the generator side to DC voltage at the DC-link voltage. The DC voltage is converted again to AC voltage with

these conventional sources are very expensive and go to depletion. If these communities are affluent in wind energy, in this case, stand-alone wind energy systems can be considered as an effective way to supply power to the loads in these communities. It is one of the practicalities for self-sufficient power generation which involves using a wind turbine with battery storage system to create a stand-alone system for isolated communities located far from a utility grid. Load side voltage source inverter is responsible to supply controlled output load voltage in terms of amplitude and frequency to the load. Wind energy supply systems are among the most interesting, low cost, and environmental friendly for supply power to remote communities which are affluent in wind energy resource.

Battery storage system is essential for a stand-alone wind energy supply system to meet the required load power. As a variable speed wind energy system which has fluctuating generated power due to the variability of wind speed. It can store the excess energy when the generated power from the wind is more than the required load power for a time when the generated power from the wind is less than the required load power to maintain power balance between generated power and required load power. Also, it can remove the fluctuating power from wind energy system and maximize the reliability of power supplied to the load.

Hence, this paper proposes a control strategy for a variable speed stand-alone wind energy supply system. Control of the switch mode rectifier at the generator side is used to achieve sensor less maximum power extraction from available wind power. Control of the DC-DC bidirectional converter, which is connected between the batteries bank and DC-link voltage, is used to maintain the DC voltage at constant value and to meet power balance of the system. Control of the voltage source inverter at the load side is used to supply controlled output voltage in terms of amplitude and frequency to the load. Simulation results demonstrate that the control strategy performs very well in spite of wind speed and required load variation.

II. INVERTERS

Conventional two-level inverters are mostly used today to generate an AC voltage from an DC voltage. The two-level inverter can only create two different output voltages for the load, $+V_{dc2}$ or $-V_{dc2}$

(when the inverter is fed with V_{dc}). To build up an AC output voltage these two voltages are usually switched with PWM, see Figure. Though this method is effective it creates harmonic distortions in the output voltage, EMI and high dv/dt (compared to multilevel inverters).

This may not always be a problem but for some applications there may be a need for low distortion in the output voltage. The concept of Multilevel Inverters (MLI) does not depend on just two levels of voltage to create an AC signal. Instead several voltage levels are added to each other to create a smoother stepped waveform with lower dv/dt and lower harmonic distortions. With more voltage levels in the inverter the waveform it creates becomes smoother, but with many levels the design becomes more complicated, with more components and a more complicated controller for the inverter is needed.

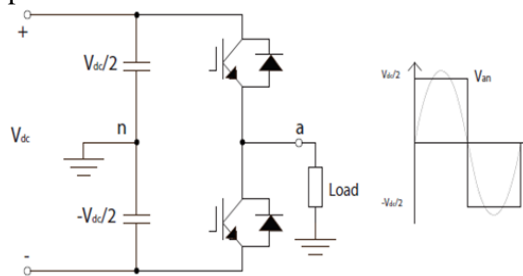

Fig. 1: Traditional single phase inverter

A single-phase square wave type voltage source inverter produces square shaped output voltage for a single-phase load. Such inverters have very simple control logic and the power switches need to operate at much lower frequencies compared to switches in some other types of inverters. In contrast, the present day switches like IGBTs are much faster and used at switching frequencies of several kilohertz. As pointed out in Lesson-26, single-phase inverters mostly use half bridge or full bridge topologies. Power circuits of these topologies are redrawn.

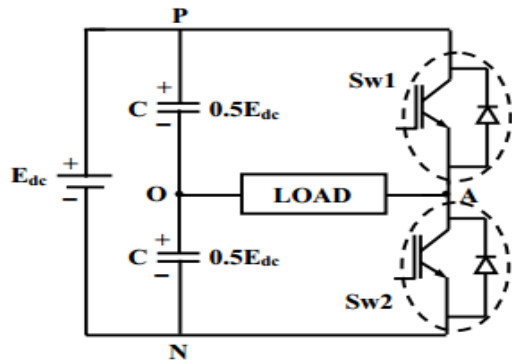

Fig. 2: A 1-phase half bridge VSI

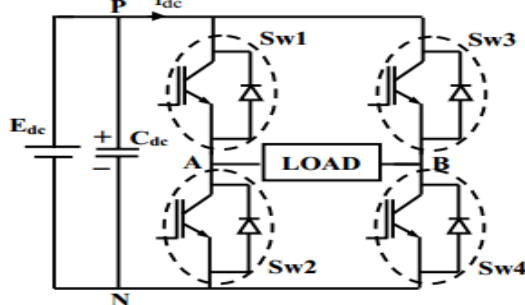

Fig. 3: A 1-phase full-bridge VSI

Both the above topologies are analyzed under the assumption of ideal circuit conditions. Accordingly, it is assumed that the input dc voltage (E_{dc}) is constant and the switches are lossless.

III. WIND POWER SYSTEM

Wind power is extracted from air flow using wind turbines or sails to produce mechanical or electrical power. Wind mills are used for their mechanical power, wind pumps for water pumping, and sails to propel ships. Wind energy as an alternative to fossil fuels, is plentiful, renewable, widely distributed, clean, produces no greenhouse gas emissions during operation and uses little land. The effects on the environment are generally less problematic than those from other power sources.



Wind power generation

(A) Collection and Transmission Network:



Typical components of a wind turbine (gearbox, rotor shaft and brake assembly) being lifted into position

Typical components of a wind turbine (gearbox, rotor shaft and brake assembly) being lifted into position in a wind farm, individual turbines are interconnected with a medium voltage (usually 34.5 kV) power collection system and communications network. At a substation, this medium-voltage electrical current is increased in voltage with a transformer for connection to the high voltage electric power transmission system.

These are important issues that need to be solved, as when the transmission capacity does not meet the generation capacity, wind farms are forced to produce below their full potential or stop running all together, in a process known as curtailment. While this leads to potential renewable generation left untapped, it prevents possible grid overload or risk to reliable service.

(B) Wind Power Capacity Production:

Worldwide there are now over two hundred thousand wind turbines operating, with a total nameplate capacity of 282,482 MW as of end 2012.^[51] The European Union alone passed some 100,000 MW nameplate capacity in September 2012,^[52] while the United States surpassed 50,000 MW in August 2012 and China's grid connected capacity passed 50,000 MW the same month

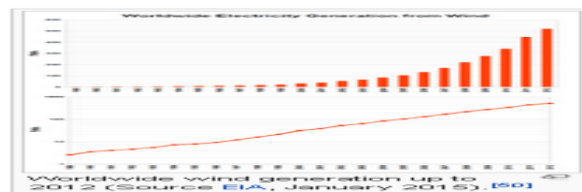

World wind generation capacity more than quadrupled between 2000 and 2006, doubling about every three years

(C) Turbine Design:

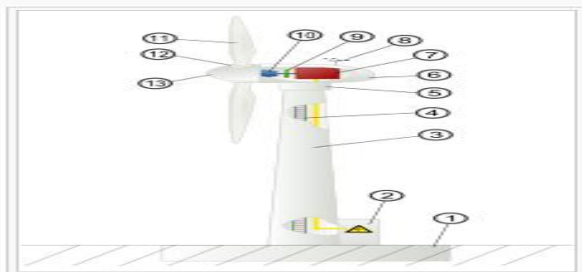

Typical wind turbine components : 1- Foundation, 2-Connection to the electric grid, 3- Tower, 4-Access ladder, 5-Wind orientation control (Yaw control), 6-Nacelle, 7-Generator, 8- Anemometer, 9-Electric or Mechanical Brake, 10- Gearbox, 11-Rotor blade, 12-Blade pitch control, 13- Rotor hub.

Wind turbines are devices that convert the wind's kinetic energy into electrical power. The result of over a millennium of windmill development and modern engineering, today's wind turbines are manufactured in a wide range of horizontal axis and vertical axis types.

(D) Hybrid Wind-Battery System for an Isolated Dc Load:

The proposed hybrid system comprises of a 4-kW WECS and 400 Ah, C/10 lead acid battery bank. The system is designed for a 3-kW stand-alone dc load. The layout of the entire system along with the control strategy is shown in Fig. 1. The specifications of the WT, SEIG, and battery bank are tabulated in the Appendix. The WECS consists of a 4.2-kW horizontal axis WT, gear box with a gear ratio of 1:8 and a 5.4 hp SEIG as the WTG.

Since the load is a stand-alone dc load the stator terminals of the SEIG are connected to a capacitor bank for self-excitation. The ac output is rectified by three-phase uncontrolled diode rectifier. However, there is a need for a battery backup to meet the load demand during the period of unavailability of sufficient wind power. This hybrid wind-battery system requires suitable control logic for interfacing with the load. The uncontrolled dc output of the rectifier is applied to the charge controller circuit of the battery. The charge controller is a dc-dc buck converter which determines the charging and discharging rate of the battery.

IV. CONTROL STRATEGY FOR STAND-ALONE HYBRID WIND-BATTERY SYSTEM

The wind flow is erratic in nature. Therefore, a WECS is integrated with the load by means of an ac-dc-dc converter to avoid voltage flicker and harmonic generation. The control scheme for a stand-alone hybrid wind-battery system includes the charge controller circuit for battery banks and pitch control logic to ensure WT operation within the rated value. The control logic ensures effective control of the WECS against all possible disturbances.

(A) Charge Controller for the Battery Bank:

This section discusses in detail the development of charge controller circuit for a 400 Ah, C/10 battery bank using a dc-dc buck converter in MATLAB/SIMULINK platform. Generally, the batteries are charged at C/20, C/10, or C/5 rates depending on the manufacturer's specification where C specifies the Ah rating of battery banks. So, the battery bank system considered in the design can be charged at 20, 40, or 80 A. But, in this paper, C/10 rate (i.e., 40 A) for battery charging is chosen. However, the current required for charging the battery bank depends on the battery SoC.

(B) Control Strategy:

The implementation of the charge control logic as shown in Fig. 2 is carried out by three nested control loops. The outer most control loop operates the turbine following MPPT logic with battery SoC limit. To implement the MPPT logic, the actual tip speed ratio (TSR) of turbine is compared with the optimum value. The error is tuned by a PI controller to generate the battery current demand as long as the battery SoC is below the CC mode limit. Beyond this point, the SoC control logic tries to maintain constant battery charging voltage. This in turn reduces the battery current demand and thus prevents the battery bank from overcharging. The buck converter inductor current command is generated in the intermediate control loop.

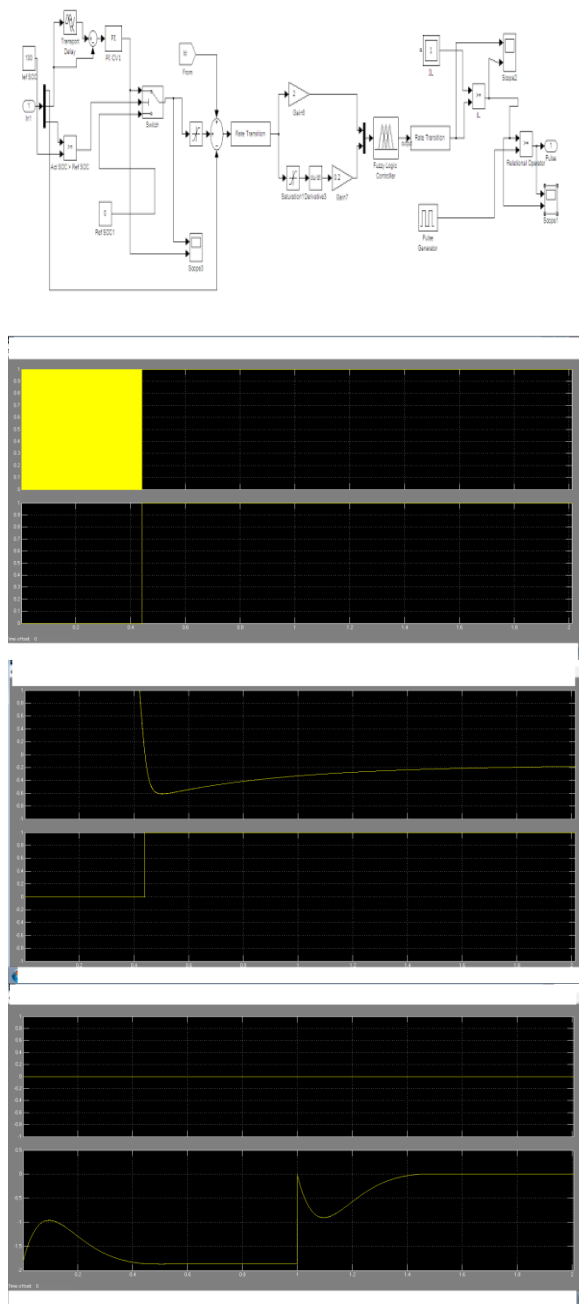

Fig.1. Control diagram and output waveforms

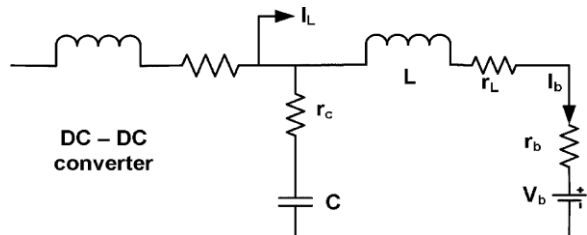

Fig.2. Circuit representation of buck converter output

The structure of the proposed control strategy of the switch mode rectifier is shown in Figure 4. The objective of this control is to control the duty cycle of DC-DC boost switch *S1* which is shown in Figure 1 to extract maximum power from available wind power. The control algorithm includes the following steps:

Estimate generator speed, ω_g

Generator speed of PMSG can be estimated by measuring the average output voltage V_d and current I_d of the uncontrolled bridge rectifier and by knowing the parameters of used PMSG in this paper which are given in Table 1. [20].

The relation among generator speed, PMSG parameters, V_d and I_d is governed by (7).

$$\omega_g = \frac{2\pi(V_d + 2R_s I_d)}{60 \left(\frac{3\sqrt{3}}{\pi} K_m - \frac{p}{2} L_s I_d \right)} \quad (7)$$

Where, ω_g is the generator speed in (rad/second).

Figure 2 gives a configuration of (7) in MATLAB/SIMULINK. The generator speed (ω_g) equal rotational speed (ω_r) where there is no gearbox between wind turbine and PMSG.

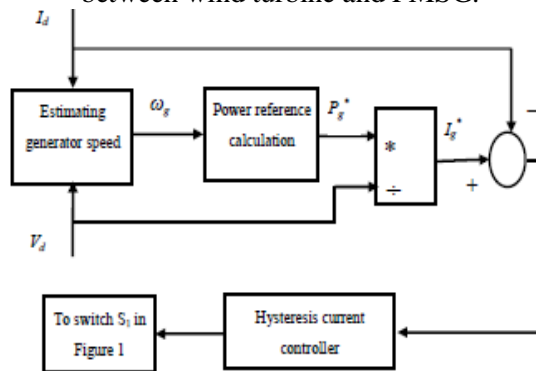

The generator side converter control strategy

V. FUZZY LOGIC MPPT CONTROLLER

In CC mode, the battery charging current demand is determined from the MPPT logic. MPPT is implemented by comparing the actual and optimum TSR (λ_{opt}). The error is tuned by a PI controller to generate the battery charging current as per the wind speed. In this mode, the converter output voltage rises with time while the MPPT logic tries to transfer as much power as possible to charge the batteries.

Fuzzy logic controllers have been introduced in the tracking of the MPP in RE system. They have the advantage to be robust and relatively simple to design as they do not require the knowledge of the exact model. They do require in the other hand the

complete knowledge of the operation of the system by the designer.

The Fuzzy Logic Algorithm used in battery charging process improves the efficiency of battery charging process and enhances the battery life. A Fuzzy Module reads the real time battery voltage and currents and Fuzzy Logically Control the battery charging current by PWM technique.

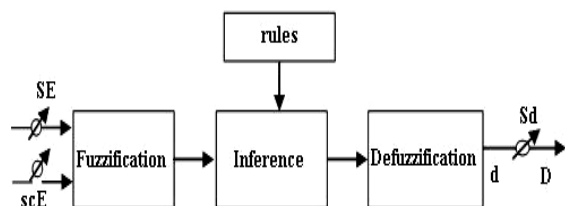

Fig.1. The proposed FL MPPT Controller

It has two inputs and one output. The two FLC input variables are the error E and change of error CE at sampled times k defined by:

$$E(k) = \frac{P_{ph}(k) - P_{ph}(k-1)}{V_{ph}(k) - V_{ph}(k-1)}$$

$$CE(k) = E(k) - E(k-1)$$

Where, $P_{ph}(k)$ is the instant power of the photovoltaic generator. The input $E(k)$ shows if the load operation point at the instant k is located on the left or on the right of the maximum power point on the PV characteristic, while the input $CE(k)$ expresses the moving direction of this point. The battery is required for storing the electrical energy generated. The lead acid battery is more commonly used, because of reliability and low cost. There are number of charging methods like Constant Voltage Method, Constant Current Method, Taper Charging Method, Pulsed Charging Method, Float Charging Method, Fast/Quick Charging Method and Trickle Charging Method. Out of these the Trickle Charging Method is more popular and commonly used. In Trickle charging method the self discharged battery is continuously charged at constant current. Initially the constant charging current is high and as reach to the predetermined set point voltage the current gradually decreases with respect to time and then after the battery charges to the constant voltage, shown in fig. This type of charging process can farther be improved by using *Fuzzy Logic Charging Algorithm*.

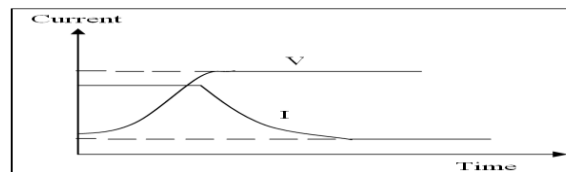

Fig.2. Trickle charging Method

(A) Battery SoC control:

The battery voltage and SoC rise fast with time. However, the charge controller should not overcharge the batteries to avoid gasification of electrolyte [14]. As a result, once the battery SoC becomes equal to the reference SoC the controller must switch over from CC mode to CV mode. In CV mode, the battery charging voltage is determined from the buck converter output voltage (V_o). The value of the converter voltage when the battery SoC reaches 98% is set as the reference value and is compared with the actual converter output voltage.

The WECS operation depends strongly on the load characteristics to which it is connected. Indeed, for a load, with an internal resistance R_i , the optimal adaptation occurs only at one particular operating point, called Maximum Power Point (MPP) and noted in our case P_{max} . Thus, when a direct connection is carried out between the source and the load, the output of the WECS is seldom maximum and the operating point is not optimal. Furthermore the characteristics of a wind turbine vary with air density and wind velocity. So, the MPPT controller is also required to track the new modified maximum power point in its corresponding curve whenever air density and wind velocity variation occurs.

VI. WIND MPPT CONTROL

In spite of the easy implementation of traditional control "PI", its response is not so good for non-linear systems. The improvement is remarkable when controls with Fuzzy logic are used, obtaining a better dynamic response from the system. Settling time can be reduced with minimum overshoots.

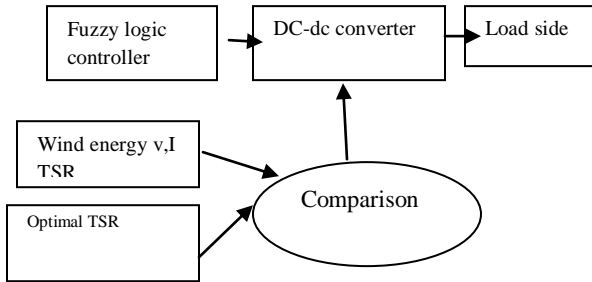

Fig1: Block diagram for Wind MPPT control

(A) Software employed:

Matlab-R2010a

MATLAB is a software package for computation in engineering, science, and applied mathematics. It offers a powerful programming language, excellent graphics, and a wide range of expert knowledge. MATLAB is published by and a trademark of The Math Works, Inc .

Simulink (Simulation and Link) is an extension of MATLAB by Math works Inc. It works with MATLAB to offer modeling, simulating, and analyzing of dynamical systems under a graphical user interface (GUI) environment.

(B) Simulation results:

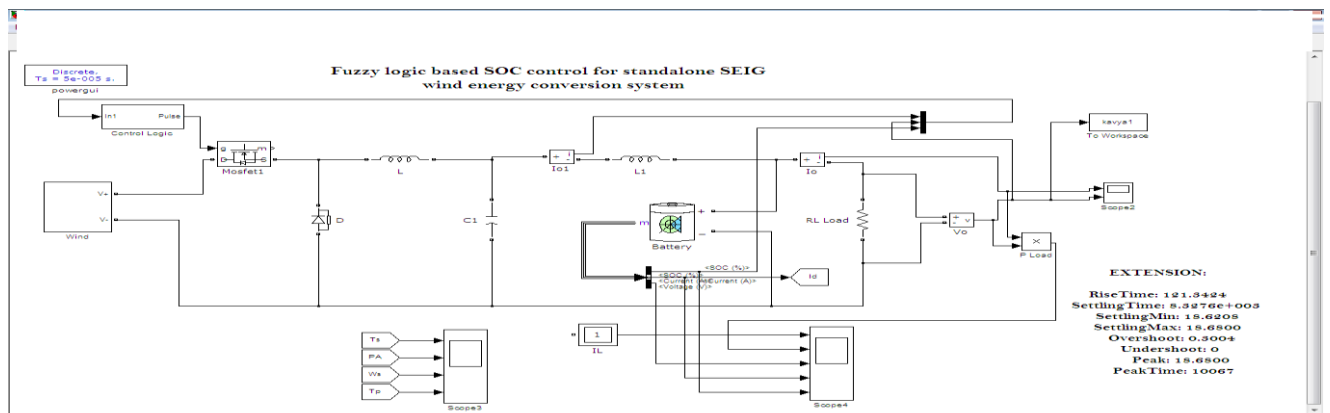
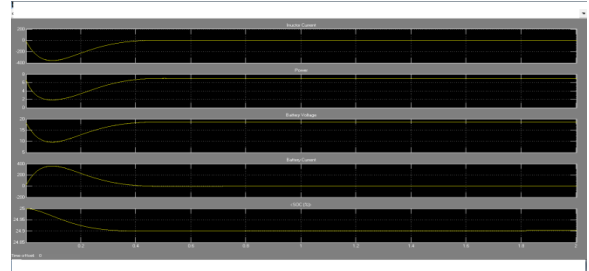
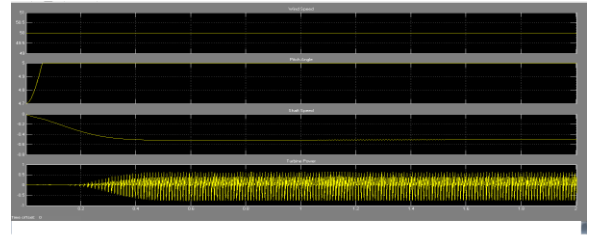
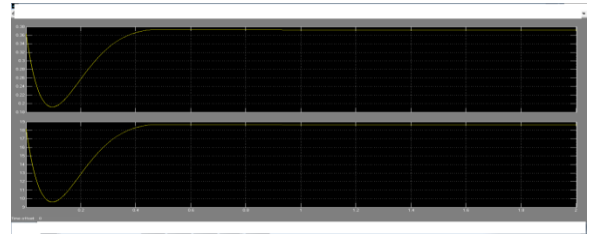

Fuzzy logic based MPPT & SoC control for standalone wind energy conversion system

VII. CONCLUSION

The power available from a WECS is very unreliable in nature. So, a WECS cannot ensure uninterrupted power flow to the load. In order to meet the load requirement at all instances, suitable storage

device is needed. Therefore, in this paper, a hybrid wind-battery system is chosen to supply the desired load power. To mitigate the random characteristics of wind flow the WECS is interfaced with the load by suitable controllers. The control logic implemented in the hybrid set up includes the charge control of battery bank using MPPT and pitch control of the WT for

assuring electrical and mechanical safety. The charge controller tracks the maximum power available to charge the battery bank in a controlled manner. Further it also makes sure that the batteries discharge current is also within the C/10 limit. The current programmed control technique inherently protects the buck converter from over current situation. However, at times due to MPPT control the source power may be more as compared to the battery and load demand. During the power mismatch conditions, the pitch action can regulate the pitch angle to reduce the WT output power in accordance with the total demand. Besides controlling the WT characteristics, the pitch control logic guarantees that the rectifier voltage does not lead to an overvoltage situation. The hybrid wind-battery system along with its control logic is developed in MATLAB/SIMULINK and is tested with various wind profiles. The outcome of the simulation experiments validates the improved performance of the system.

ACKNOWLEDGEMENT

I would like to thank my professors for the interest and support and the permission to publish the paper.

REFERENCES

- [1] Muller, S.; Deicke, M.; de Doncker, R.W. Doubly fed induction generator system for wind turbines. *IEEE Ind. App. Mag.* **2002**, *8*, 26–33.
- [2] Ackerman, T.; Soder, L. An overview of wind energy status 2002. *Renew. Sus. Energy Rev.* **2002**, *6*, 67–127.
- [3] Bleij, J.A.M.; Chung, A.W.K.; Rudell, J.A. Power Smoothing and Performance Improvement of Wind Turbines with Variable Speed. In Proceeding of 17th British Wind Energy Association Conference, Warwick, UK, 19–21 July 1995; pp. 353–358.
- [4] Chan, T.F.; Lai, L.L. Permanent-Magnet Machines for Distributed Generation: A Review. In Proceeding of the IEEE Conference on Power Engineering Society General Meeting, Tampa, FL, USA, 24–28 June 2007; pp. 1–6.
- [5] Westlake, A.J.G.; Bumby, J.R.; Spooner, E. Damping the power-angle oscillations of a permanent magnet synchronous generator with particular reference to wind turbine applications. *IEE Proc. Elec. Power Appl.* **1996**, *143*, 269–280.
- [6] Polinder, H.; van der Pijl, F.F.A.; de Vilder, G.J.; Tavner, P.J. Comparison of direct-drive and geared generator concepts for wind turbine. *IEEE Trans. Energy Convers.* **2006**, *3*, 725–733.
- [7] Senjyu, T.; Tamaki, S.; Muhando, E.; Urasaki, N.; Kinjo, H.; Funabashi, T.; Fujita, H.; Sekine, H. Wind velocity and rotor position sensorless maximum power point tracking control for wind generation system. *Renew. Energy* **2006**, *31*, 1764–1775.
- [8] Fan, L.; Miao, Z.H.; Wang, X. Sensorless Maximum Power Point Tracking in Multi-Type Wind Energy Conversion Systems. In Proceeding of the 48th IEEE Conference on Decision & Control, Shanghai, China, 15–18 December 2009; pp. 6823–6828.
- [9] Hussein, M.M.; Orabi, M.; Ahmed, M.E.; Sayed, M.A. Simple Sensorless Control Technique of Permanent Magnet Synchronous Generator Wind Turbine. In Proceeding of the IEEE International Conference on Power and Energy, Kuala Lumpur, Malaysia, 29 November–1 December 2010; pp. 512–517.
- [10] Chinchilla, M.; Arnaltes, S.; Burgos, J.C. Control of permanent-magnet generator applied to variable-speed wind-energy system connected to the grid. *IEEE Trans. Energy Convers.* **2006**, *21*, 130–135.
- [11] Thongam, J.S.; Bouchard, P.; Ezzaidi, H.; Ouhrouche, M. Wind Speed Sensorless

Maximum Power Point Tracking Control of Variable Speed Wind Energy Conversion Systems. In Proceeding of the IEEE International Conference on Electric Machines and Drives, Miami, FL, USA, 3–6 May 2009; pp. 1832–1837.

AUTHORS

1.



Kavya Lingampally received the B.Tech degree in electrical and Electronics engineering from Bhoj Reddy College of engineering for Women, JNTUH, Hyderabad, Telangana, India, in 2013, and perusing m.tech in Electrical Power Engineering from sri indu college of engineering and technology, Hyderabad, Telangana, India.

2



Mr. J. Rakesh Sharan received B.Tech degree in Electrical and Electronics Engineering from Asifia College of Engineering &Technology, JNTUH, and Hyderabad in 2007 and received M.Tech in Electrical Engineering from Bharat institute of Engineering and Technology, JNTUH, Hyderabad in 2011. Currently he is working as Assistant Professor at Sri Indu college of Engineering and Technology, an Autonomous Institution, JNTUH, Telangana, India